



THE OIL FIRED EXPERIENCE

# SENATOR and COUNTRYMAN System-Boilers



Installation & Users Guide

<b>INTRODUCTION</b>	<b>Page</b>
- WARRANTY	2
<b>USER INSTRUCTIONS</b>	
- BOILER OPERATION	3
- SWITCHING THE BOILER ON	3
- BOILER CONTROLS	4
- SWITCHING THE BOILER OFF	5
- BURNER LOCKOUT	5
- RESTARTING AFTER LOCKOUT	5
- RESTART	6
<b>INSTALLATION</b>	
- REGULATIONS	7
- WATER CONNECTIONS	7
- BOILER LOCATION	8
- SERVICE REQUIREMENTS	9
- THE HEARTH	9
- CONTROL PANEL	9
- PREFORMED PIPE WORK	10
- SEALED SYSTEM	10
- PLASTIC PIPE	10
- CAPACITIES OF EXPANSION VESSEL	11
- EXPANSION VESSEL SIZING	11
- WARNING SEALED SYSTEM	11
- FILLING SYSTEM	11
- SENATOR CONVENTIONAL FLUE INSTALLATION	12
- BALANCED FLUE INSTALLATION (INTERNAL)	13-21
- CONNECTING OIL SUPPLY	21-22
- ELECTRICAL CONNECTION (INTERNAL & EXTERNAL)	23
- WIRING DIAGRAM (INTERNAL)	23
<b>TECHNICAL DATA</b>	
- BOILER SPECIFICATIONS	24-25
- COMMISSIONING INSTRUCTIONS	26
- <b>SERVICING INSTRUCTIONS</b>	27
- <b>FAULT FINDING COMBUSTION</b>	28
- PARTS LIST	29
- <b>BURNER SETTINGS</b>	30

## INTRODUCTION

Thank you for choosing the INTERNAL or EXTERNAL COUNTRYMAN COMBI oil boiler please read the following carefully.

### To the installer

This manual must be left with the householder by the installer who will instruct the user on the boiler operation.

### To the user

Please read the user section of this manual to familiarize yourself with the boiler operation.

## WARRANTY

### ***WARRANTY FOR YOUR BOILER MUST MEET THE FOLLOWING CONDITIONS OR YOUR WARRANTY MAY BE INVALID***

Warranty on the Heat Exchanger: 5 Years

Warranty on Burner and Controls: 2 years

### **CONDITIONS OF WARRANTY:**

1. Boiler MUST BE **installed** by an OFTEC registered engineer, if not permission will be required by building control.
2. Boiler MUST BE **commissioned** after installation by an OFTEC registered engineer.
3. Boiler MUST BE **serviced** every 12 months after installation by an OFTEC registered engineer.
4. Installer MUST COMPLETE an **Installation/Commissioning Form**, which will be found along with your manual and this must then be returned to the address on the warranty form. Failure to return this form, may invalidate your warranty.

## USER INSTRUCTIONS

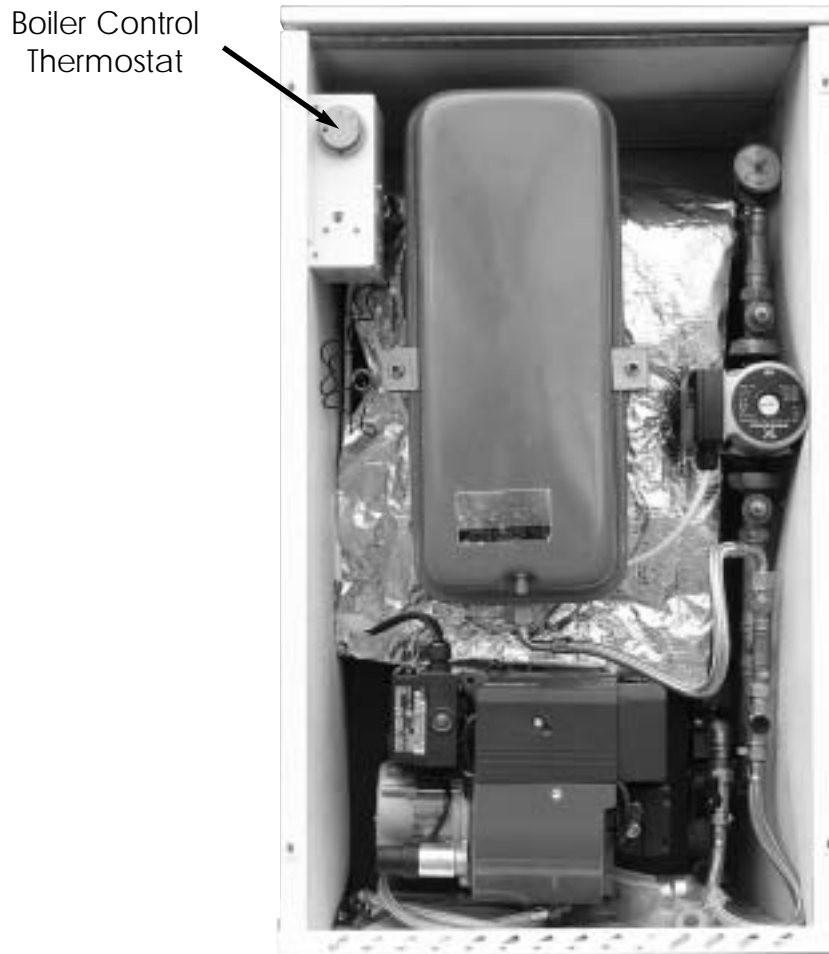

### **BOILER OPERATION**

The Boiler Control Thermostat responds to the temperature of the water within the boiler and switches power to the burner when heat is required.

The burner has an independent control system which regulates the firing and (shut-off) of the burner.

Automatic firing of the burner will occur when the water temperature within the boiler falls below the control thermostat set point which will continue to run until the water temperature rises to the temperature (recommended) set on the boiler control thermostat.

### **SWITCHING THE BOILER ON**

- Check there is water in the system.
- Check radiator valves are on.
- Turn on oil supply.
- Switch electrical supply to the boiler on (including time clock ) and then set the boiler control thermostat to recommended setting.

## BOILER CONTROLS

### BOILER CONTROL THERMOSTAT

The temperature of the water within the boiler is controlled and maintained by the **Boiler Control Thermostat** located on the boiler control panel.

### TEMPERATURE SETTINGS:

The Boiler Control Thermostat has a range of 50°C to 80°C. The recommended setting for the boiler control thermostat is:

#### WINTER

Heating and hot water supply 80°C

#### SUMMER

Domestic hot water supply 65°C

It is not recommended to operate the boiler with a thermostat setting of less than 60°C, as this will precipitate corrosion, thus reducing the life of the boiler.

### HIGH LIMIT STAT INDICATOR:

The high limit lockout will occur when the water within the boiler is or has overheated e.g. reached a temperature above that set on the high limit thermostat.

### TO RESET THE BOILER

When the boiler has had time to cool, the manual reset button (coloured red) on the control panel will need to be pressed in to reset. If the high limit thermostat continues to trip, contact your installer as there may be a fault with the central heating system.

### LOCKOUT INDICATOR: RED

The lock out indicator will illuminate when the burner has failed to fire, e.g. No fuel or an electrical fault.



Burner Control Box

Reset Button



## **SWITCHING THE BOILER OFF**

The boiler can be turned off by turning the rocker switch, located on the underside of control panel, to the OFF position.

**PLEASE NOTE:** For longer periods of shutdown e.g. While away on holiday, switch **OFF** the mains (electrical supply) and turn **OFF** the OIL supply.

If shutdown occurs during cold weather ensure boiler is protected against frost damage.

## **BURNER LOCKOUT**

The burner has an independent control system (Burner Control Box); this includes a flame detector (Photocell) which senses the presence of a flame. In the event of flame failure, the burner Control Box activates a second re-ignition sequence. Should the Photocell not detect a flame presence within 15 seconds the burner goes to LOCKOUT and shuts down.

Continued **LOCKOUTS** are a result of a fault in the operation of the boiler and can be attributed to following examples:

- An interruption of the fuel supply .
- Electrical Supply fault e.g. Extreme low voltage.
- Failure of a Burner component.
- A fault within the heating system .
- Burner combustion not being correct.

The Burner Reset button on the Control Box and the red Lockout Indicator on the boiler control panel illuminates to indicate that a lockout has occurred.

In the event of the Burner locking out, do not attempt to restart the Burner by pressing the Reset Button on the Burner Control Box for at least 2 minutes. A Bi-metallic timer within the Control Box has a minimum cooling time of 45 seconds thus the 2 minute interval will ensure that this Bi-metallic timer has cooled and is therefore in a position where it may be reset

## **RESTARTING AFTER LOCKOUT**

When lockout has occurred, inspect for any obvious causes e.g. oil leaks.

Also check the fuel line from the tank to the boiler and that any oil shut off valve has not been inadvertently closed.

## RESTART

- Check there is adequate oil in the storage tank.
- Check oil supply valves are open.
- Switch on heating system (e.g. Time clock).
- Depress the red Burner Reset Button on the burner Control Box, which will be illuminated. Both Burner Reset Button (illuminated) and the lockout Indicator on the Control Panel will go out and the burner will commence the ignition start sequence. After 15 seconds the Burner should fire normally.

**PLEASE NOTE:** Should the Burner not start, both lockout indicator, on the Control Panel and Burner Reset Button will illuminate again.

- Wait at least 3 minutes and depress the Burner Rest Button again.  
Failure to start a second time indicates a fault requiring attention.  
In the event of a second failure to start:
  - Switch off electrical supply.
  - Call service engineer.

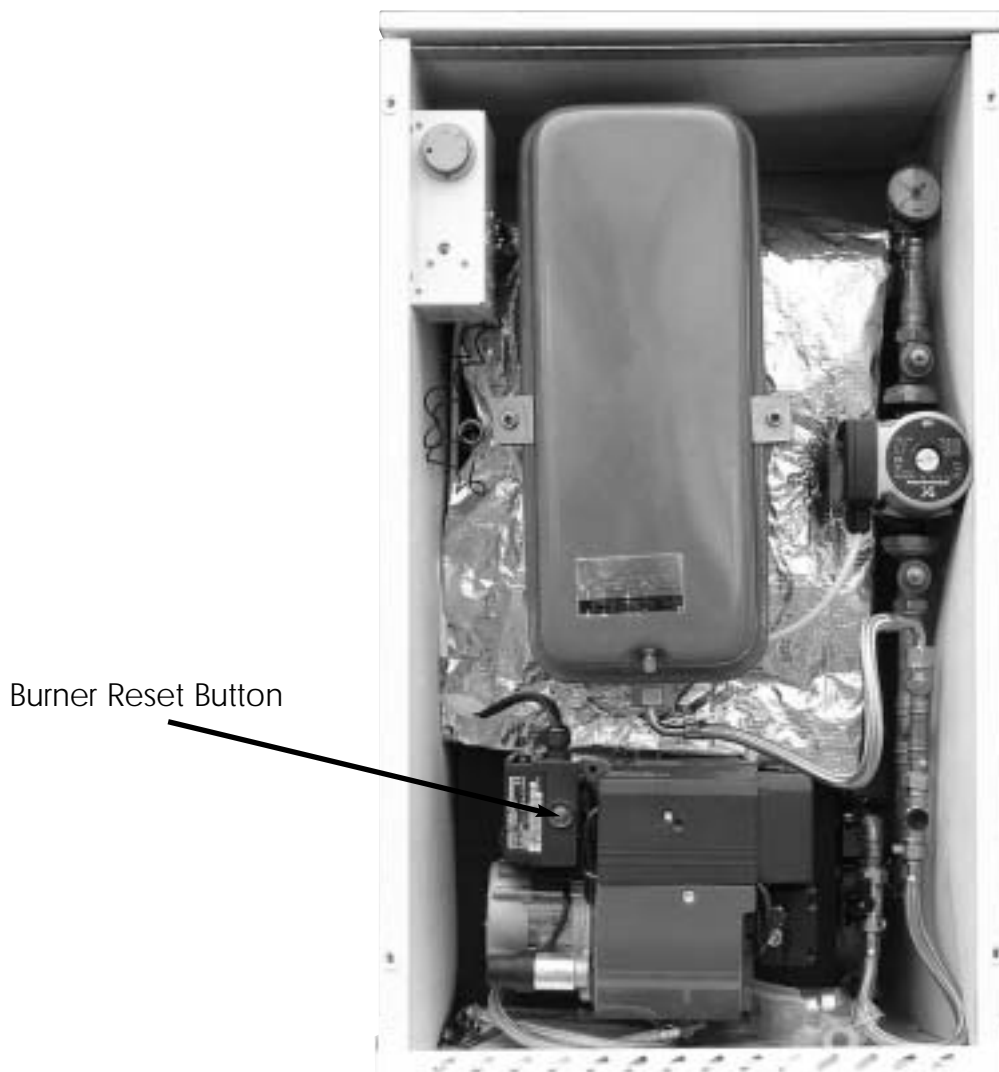

## REGULATIONS

The installation of oil fired boilers should comply with the following standards and codes of practice.

- BS5449 Forced circulation hot water heating systems for domestic use
- BS5410-Part1 Oil installations up to 45kw.
- BS7593 Water treatment of hot water central heating systems.
- BS7671 Electrical Regulations.
- BS7074 Code of practice for sealed systems
- Building Regulations Part L1 and J 2002 England and Wales, Part F Scottish Regulations and Technical Booklet L Northern Ireland.
- OFTEC Codes of Practice Published or Recommended.

After installing the system, it needs to be flushed with a cleanser like Fernox Heavy Duty Restore, for fast-acting removal of lime scale, black sludge (magnetite) and other deposits from the boiler and the central heating system. Then add a Fernox protector to give long term protection of the central heating system against internal corrosion and lime scale formation.

## WATER CONNECTIONS

The boiler is supplied with one flow and two return connections. Diagrams below show pipe configurations.

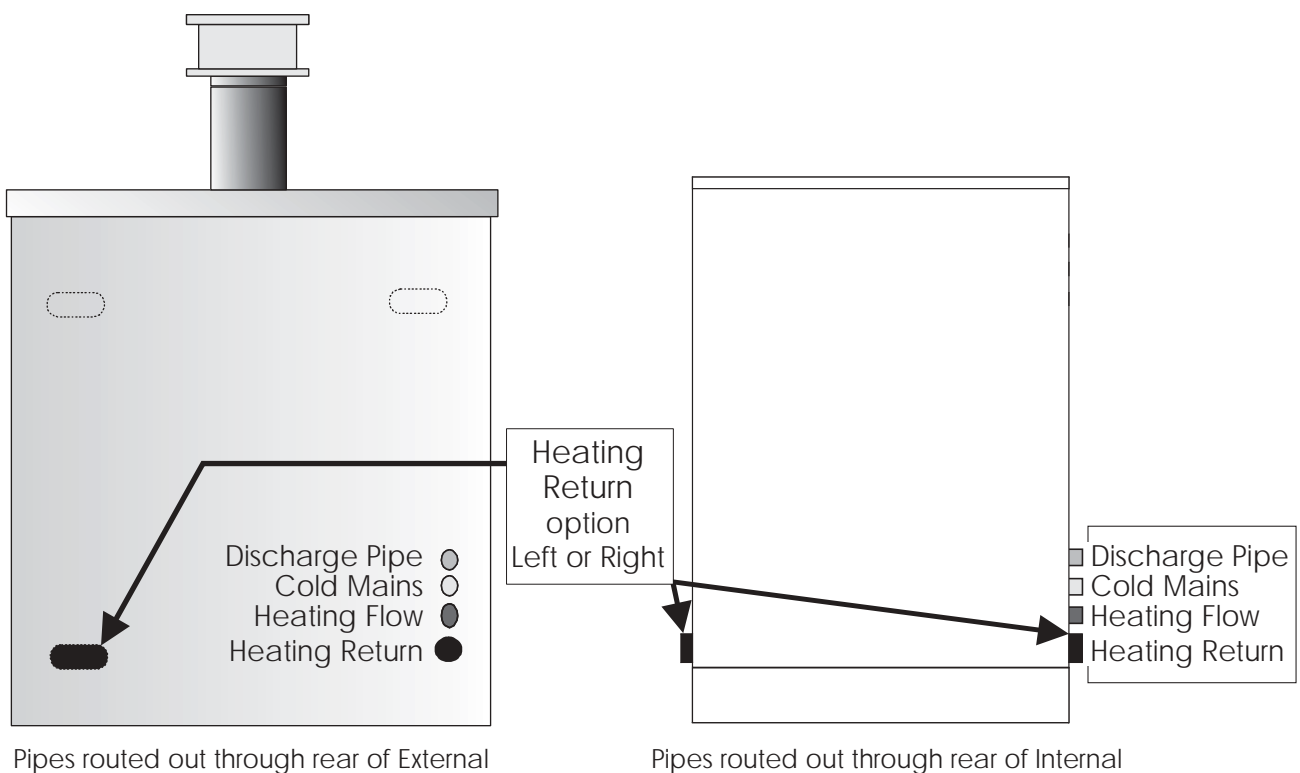

## BOILER LOCATION

Sound levels should be discussed with the householder, as some people may be sensitive to low noise levels in a small room, as it may appear more annoying than in a larger room. Please Note installation should take into account of flue position (see diagram).

## RECOMMENDED FLUE POSITION

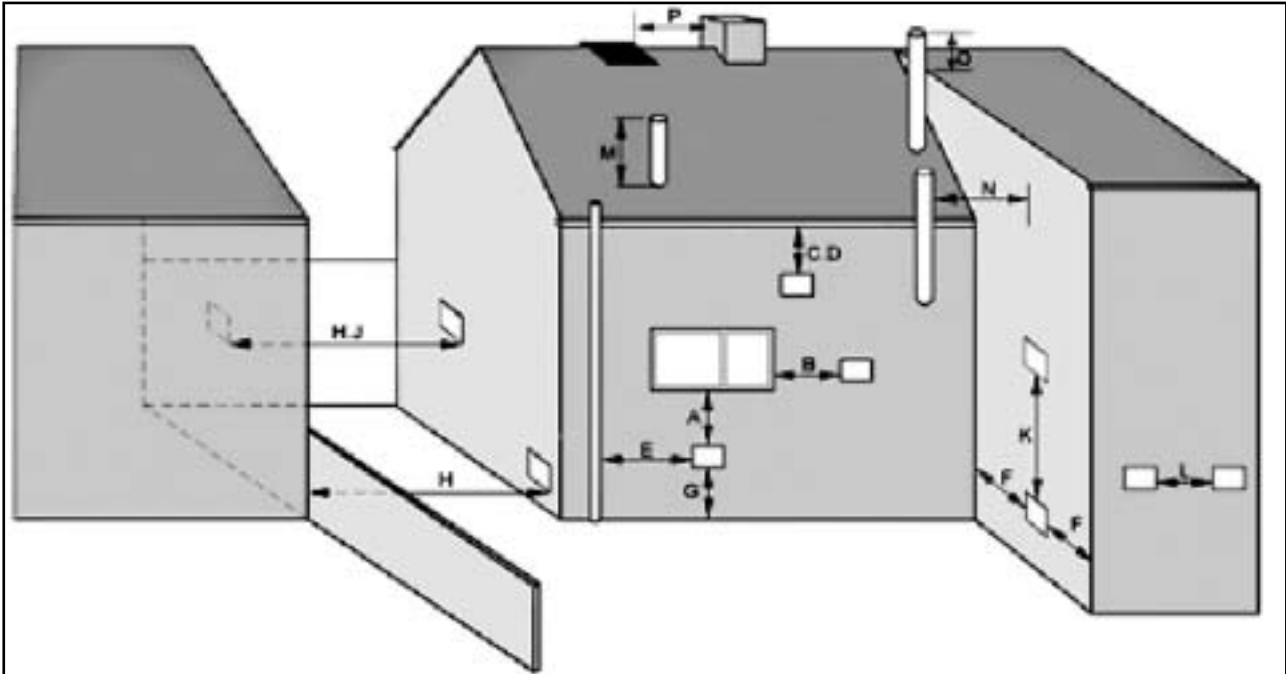

Please Note where the terminal is within 1 metre of any plastic material, such material should be protected from the effects of the combustion products of the fuel.

**IMPORTANT 35 SECOND CLASS D GAS OIL MUST NOT BE USED FOR BALANCED FLUES.**

Ref	Min. Position	mm
A	Directly below an opening, air brick, opening window etc.	600
B	Horizontally to an opening , air brick, opening window etc.	600
C	Below a gutter, eaves or balcony with protection.	75
D	Below a gutter or a balcony without protection.	600
E	From vertical sanitary pipework.	600
F	From an internal or external corner.	600
G	Above ground or balcony level.	600
H	From a surface or a boundary facing the terminal.	600
J	From a terminal facing the terminal.	1200
K	Vertically from a terminal on the same wall.	1500
L	Horizontally from a terminal on the same wall.	750
M	Above the highest point of an intersection with the roof.	600
N	From a vertical structure on the side of the terminal.	750
O	Above a vertical structure less than 750mm.	600
P	From a ridge terminal to a vertical structure on the roof.	1500

## INSTALLATION

### SERVICE REQUIREMENTS

The boilers are serviced through an access panel at the front. A service access space of least 700mm should be made available at the front of the boiler.

### THE HEARTH

The temperature of the surface below the boiler is less than 85°C. If the floor under the boiler is of combustible material, then protection such as steel should be fitted between the boiler and the floor.

Consideration should be given to the weight of the filled boiler, the floor must provide adequate support. Please consult the building regulations for safe floor loadings.

### CONTROL PANEL

The boiler control panel is factory fitted prior to despatch. The phials of the Control and High Limit Thermostat are inserted into the horizontal pocket situated on the left hand side of the boiler heat exchanger.

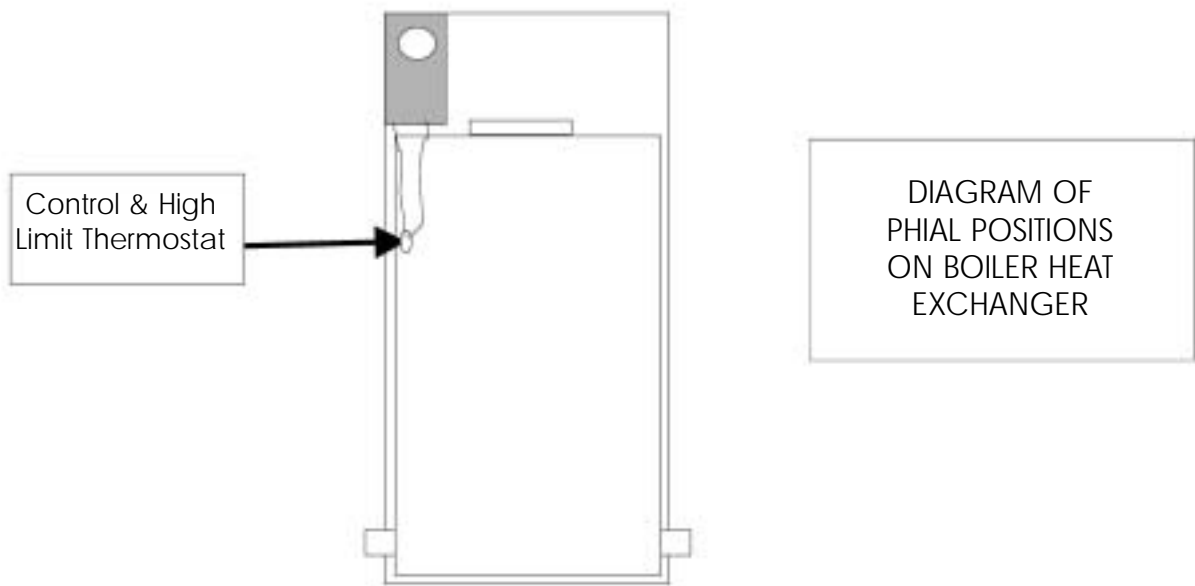

### ELECTRICAL ENTRY

The electrical supply to the boiler must be 230 volts, 50 Hz, fused at 5A. Connection of the appliance and any system controls, to the mains supply, must be a common isolator and must be fused at 5A maximum.

This must be fixed wired to a double pole isolating switch, that has a maximum contact separation of 2mm in both poles. The Isolator should be clearly marked showing its purpose, and preferably positioned close to the boiler.

## **PREFORMED PIPE WORK**

- 1 Of 22 mm section label Heating Flow
- 1 Of 22 mm section label Heat Return
- 1 Of 15 mm section label Cold Mains
- 1 Of 15 mm section label Over Flow

Prefomed pipes, on the Internal system exit on the right hand side of the boiler. from the front view of the boiler.

The preformed pipe on the External combi exits at the rear of the casing.  
For diagrams on pipe layout go page 7.

The heating return pipe (22mm) can be connected to either the left or right hand side with the tapping at the bottom rear of the boiler. The unused tapping must be blanked off.

These tappings are 1" B.S.P.

## **SEALED SYSTEM**

This boiler operates on a sealed system. A pressure relief valve operating at 3 bar is fitted.

The over flow pipe must terminate in compliance with current building regulations.

This boiler is supplied with a 12 litre expansion vessel. It is the installers responsibility to ensure adequate provision is made for expansion within the heating system and to install extra capacity if required. Damage to components caused by over expansion, may not be covered by warranty.

Unsuitable pipework and fittings and factors such as sediment or residue left in the system, may cause damage to your boiler and its components and may not be covered by warranty.

## **PLASTIC PIPE**

PLEASE NOTE: When using plastic pipe on heating system, a minium of 2 metres of copper pipe must be used off the boiler, before connecting to plastic pipe.

***PLASTIC PIPE MUST NOT IN ANY CIRCUMSTANCES BE CONNECTED DIRECTLY TO THE BOILER***

## CAPACITIES OF EXPANSION VESSELS

Safety Valve Setting @	3	3	3
Vessel charge and Initial System Pressure (BAR GAUGE)	0.5	1	1.5
LITRES	LITRES	LITRES	LITRES
5	2.1	2.7	3.9
50	4.2	5.4	7.8
75	6.3	8.2	11.7
100	8.3	10.9	15.6
125	10.4	13.6	19.5
150	12.5	16.3	23.4
175	14.6	19.1	27.3
200	16.7	21.8	31.2
225	18.7	24.5	35.1
250	20.8	27.2	39.0
275	22.9	30.0	42.9
300	25.0	32.7	46.8
325	27.0	35.7	50.7
350	29.1	38.1	54.6
375	31.2	40.9	58.5
400	33.3	43.6	62.4
425	35.4	46.3	66.3
450	37.5	49.0	70.2
500	41.6	54.5	78.0
Multiplying Factors for other system Volumes	0.0833	0.109	0.156

## EXPANSION VESSEL SIZING

Bs7074:Part1:1989 gives full details of accurate method of calculating the required expansion vessel capacity, assuming that full and accurate design information is available, particularly total system water content.

However, in practice, it is often not possible to calculate the system water contents with any certainty, and therefore estimates must be made.

The following volume approximations can be used to give a reasonable estimate of total system volume.

50/70 SYSTEM	20 Litres
KW RATING 14.65-20.5	
SMALL BORE PIPEWORK	1 Litre Per Kw of System Output
STEEL PANEL RADIATORS	8 Litres Per Kw of System Output
LOW WATER CAPACITY RADIATORS MODERN TYPE	2 Litres Pre Kw of System Output
HOT WATER CYLINDER	2 Litres

**Note:** As an approximation, BS7074: Part 1 suggests that figure of 12 litres/kw of boiler output could be used to estimate total system water content-this would be generous for most systems.

### EXPANSION VESSEL SIZING

Having determined the total system water content, expansion vessel sizing can be considered. Taking into account the other system design factors.

Full details of expansion vessel sizing and Altecnic models available are given in the expansion vessel data sheet.

However, Altecnic expansion vessels are supplied pre-charged at 1bar (suitable for system static heads up to 15 metres) and the safety valve normally pre-set at 3 bar (British Specification).

For standard conditions therefore, the following table can be used to select the required expansion vessel volume.

NB: Please note the above information (EXPANSION VESSEL SIZING) is only a guide therefore we do not accept responsibility for sizing of systems and this does not over rule British Standards always refer back to BS7074: Part 1 if in doubt.

### WARNING SEALED SYSTEM

This boiler operates on a sealed system up to a maximum pressure of 3 bar. It is the responsibility of the installer to ensure all pipework and fittings are suitable for use under these circumstances. This boiler is supplied with a 12 litre expansion vessel. It is the installers responsibility to ensure adequate provision is made for expansion within the system and to install extra capacity if required.

Damage to components caused by over expansion may not be covered by warranty. Unsuitable pipework and fittings and factors such as sediment or residue left in the system, may cause damage to your boiler and its components this will not be covered by warranty.

### FILLING THE SYSTEM

Prior to filling, the system must be thoroughly flushed using a cleaning agent. The system must then be vented of all air and recharged to maximum of 1.5 bar.

## SENATOR CONVENTIONAL FLUE INSTALLATION

The boiler is supplied as standard for use with conventional flue.

The chimney must comply with building regulations and B S 5410. Factory made insulated chimneys are covered by B S 4543 Parts 2 & 3.

Notes on Conventional Flue

1. **Liner** A stainless steel flue liner of diameter to suit the boiler is recommended.
2. **Flue pipe** can be of vitreous enamel or stainless steel.
3. **Bends** Bends in the flue pipe should not be greater than 135 degrees.
4. **Insulation** Insulation between the flue pipe and brick chimney, is recommended to minimize the occurrence of condensation.
5. **Cowls** Cowls and pots that may restrict the flue should not be used.
6. **Draught Stabiliser** Chimneys over 6 metres high may produce excessive draught (over 4mm w.g.). Draught stabilizers may be required.
7. **Length** Before bends are applied, length of flue must be at least 600mm.

## COMBUSTION AIR SUPPLY - CONVENTIONAL FLUE

INFORMATION SUPPLIED BY OFTEC

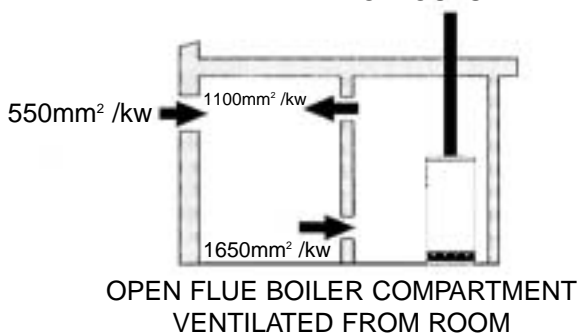
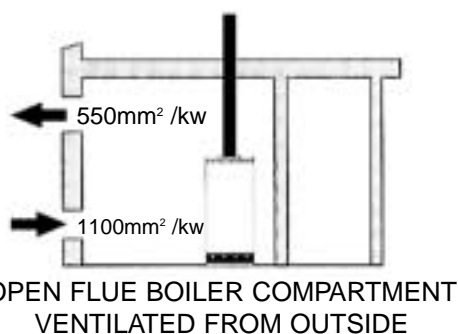
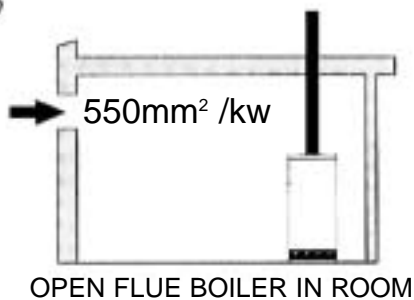

Conventional Flue - Typical Arrangement

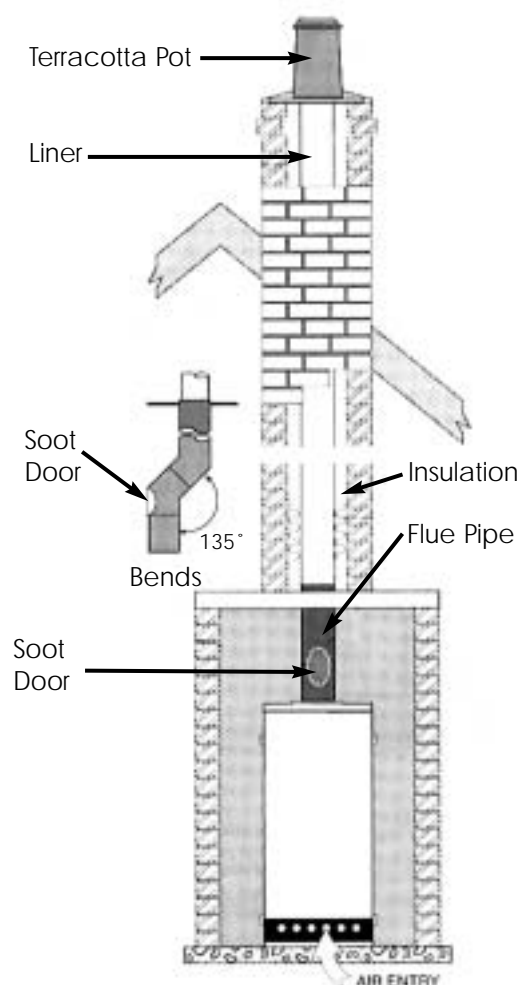

## BALANCED FLUE INSTALLATION

### VENTILATION AIR SUPPLY

Air ventilation for balanced flue boilers is only required if the boiler is installed in a confined space e.g. a cupboard. This is to prevent over heating of components.

#### BALANCED FLUE BOILERS

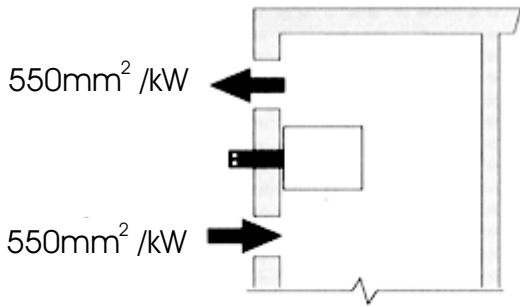

BOILER IN COMPARTMENT  
VENTED FROM OUTSIDE

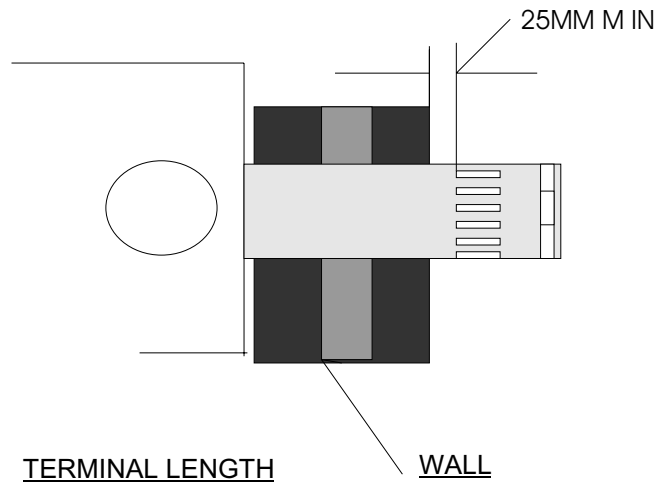
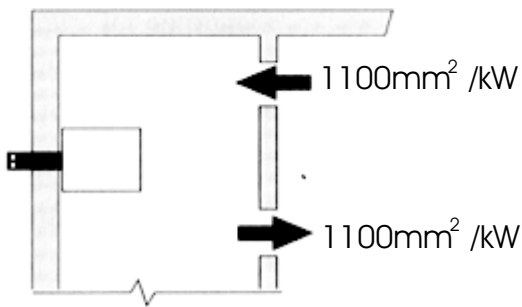

### LOW LEVEL BALANCED FLUE

NOTE If flueing from the side of the boiler. Combi preformed pipes must go opposite to the side on which the flue is flueing from.

NOTE If flueing from the right hand side of the boiler when looking from the front of the boiler, then a flue extension maybe required.

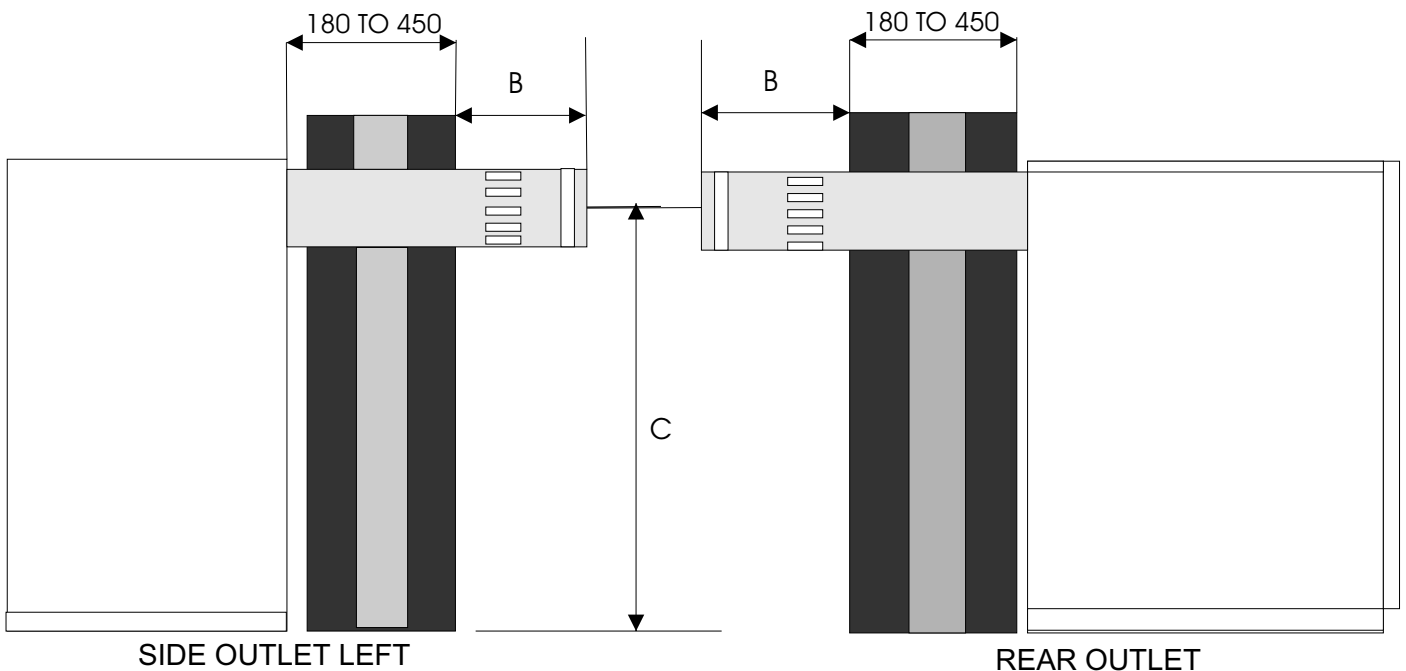

**LOW LEVEL BALANCED FLUE**

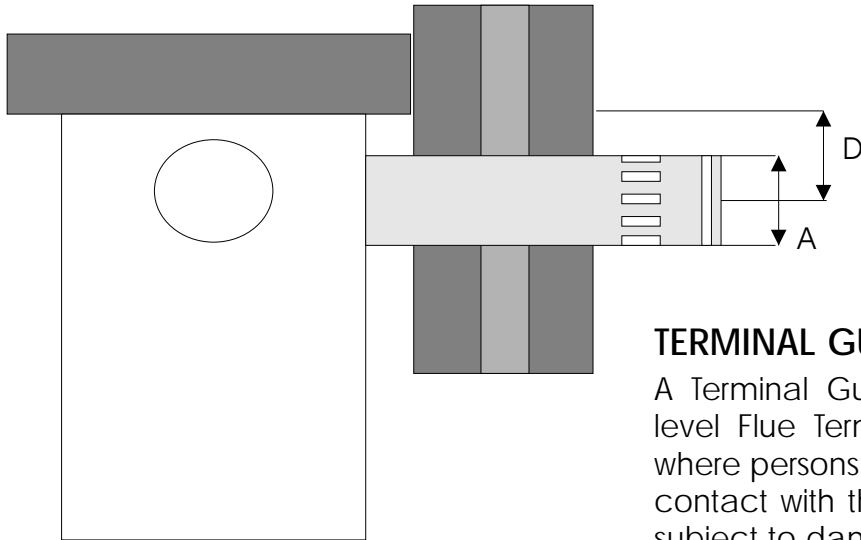

**TERMINAL GUARD**

A Terminal Guard must be fitted to low level Flue Terminal below 2 metres and where persons or animals could come into contact with the terminal or if it could be subject to damage.

MODEL	Flue	A	B	C	D
50/70	3"	125	176	765	130
70/90	3"	125	176	765	130

**LOW LEVEL BALANCED FLUE SIDE AND REAR ASSEMBLY INSTALLATION**



REMOVE CASING LID

1. Cut hole in wall. Remember measure, mark, CHECK then cut.
2. Remove Conventional Flue ring from top of boiler.
3. Fit Red inner seal and Black out Seal to flue connector and extension if required.
4. Apply lubricant included in kit. To the inner and outer seal taken care to only lubricant the lip of the seal.



REMOVE FOIL

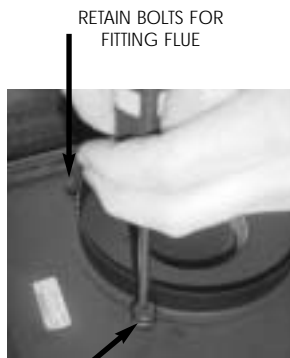

REMOVE FLUE RING

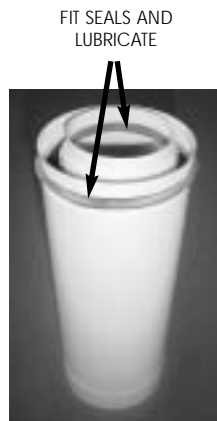

FIT SEALS AND LUBRICATE



FIT SQUARE GASKET



FIT BOLTS

5. With boiler in position pass the flue assembly through the wall and bolt the bottom section of the flue to the boiler, insuring that square gasket is in between the boiler and the flue.

6. Attached the snorkel tube with clips to the flue.

7. Make sure that flue terminal protrudes through the wall a minimum of 176mm.

## FLUE EXTENSION

The maximum horizontal flue level is 1450mm this can be achieved using the following extension kits:

3 x kit 3 300mm extension

OR

1 x kit 6 950mm extension

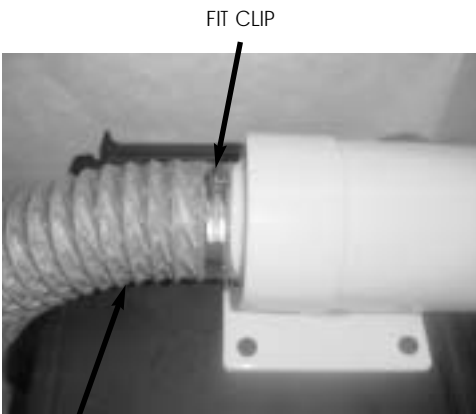

FIT SNORKEL TUBE

8. Remove CF adaptor from burner and discard.

9. Fit the gasket and B F adaptor and connect snorkel Tube.

N.B. Kit 8 45 degree bends must not be used on low level balanced flue kits.

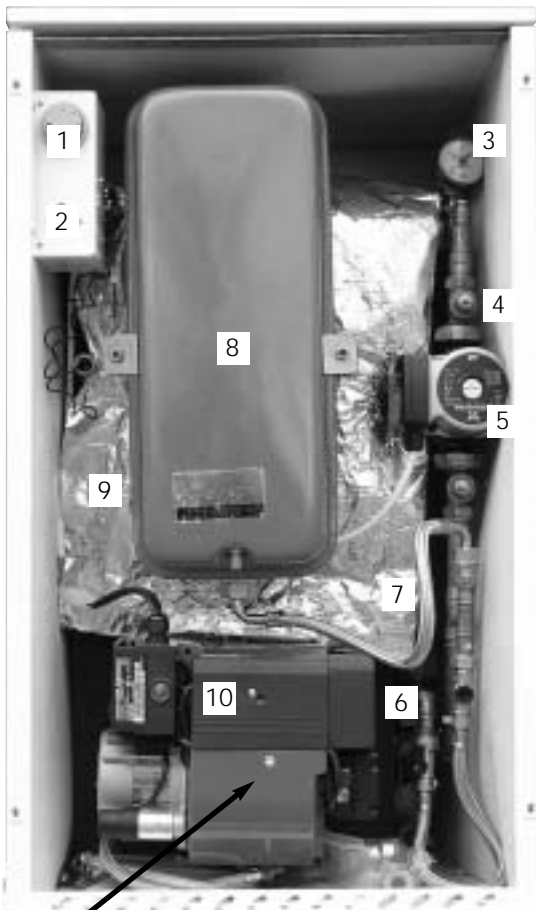

INTERNAL VIEW

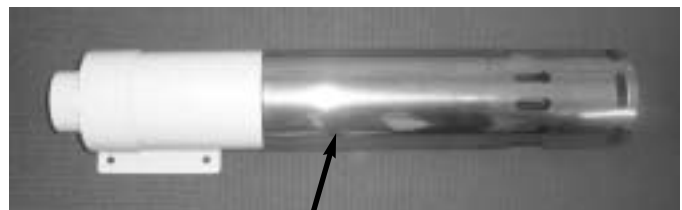

HORIZONTAL FLUE

ITEM	DESCRIPTION	PART No.
1	Control Thermostat	COTHCS
2	High Limit Thermostat	COTHHL
3	Safety Relief Valve	COMPRES
4	Gate Valves	COMGATE
5	Grundfos 25-50	GRUN50
6	Filling Loop	COMLOOP
7	Expansion Vessel Hose	COMHOS
8	12 Litre Expansion Vessel	COM12L
9	Door Insulation Kit	INSKIT
10	50/70 Baffle 70/90 Baffle Burner See Burner Parts List	

## HIGH LEVEL BALANCED FLUE

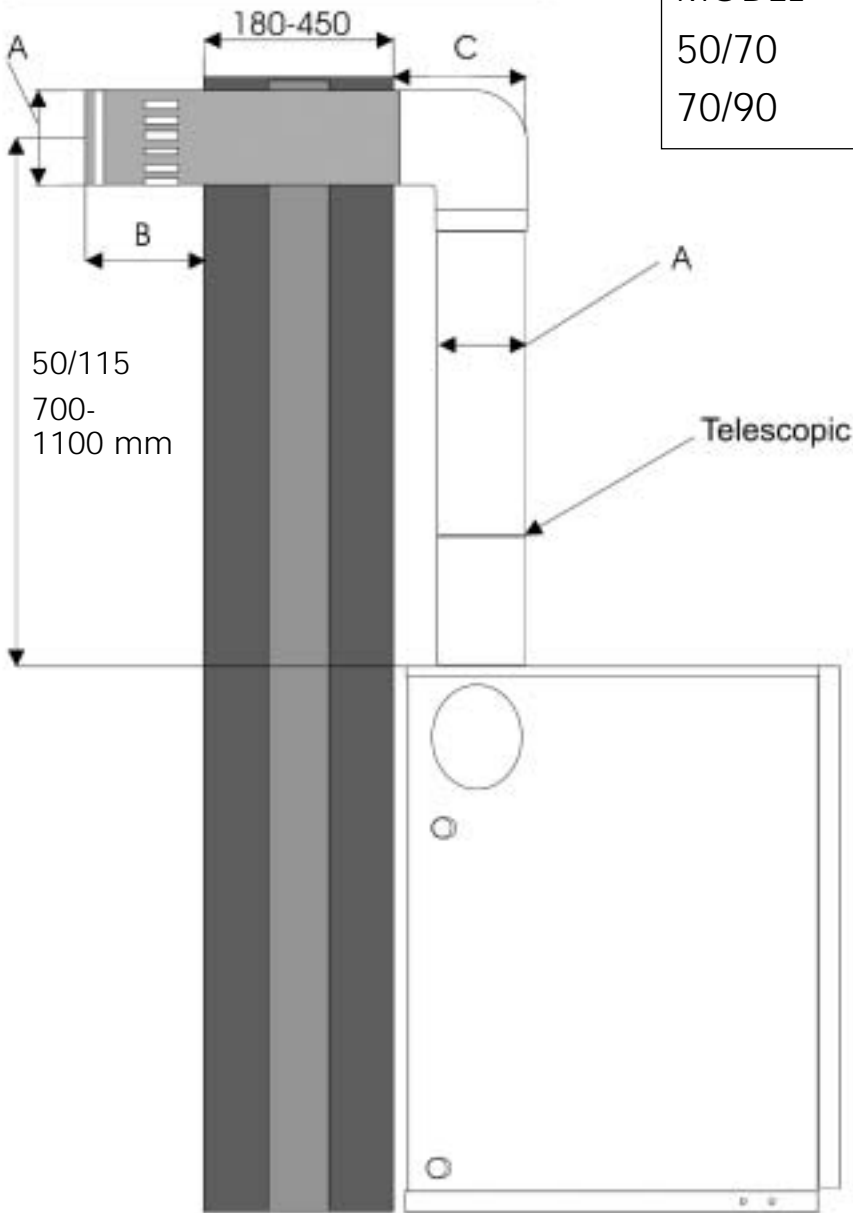

MODEL	Flue	A	B	C
50/70	3"	125	176	200
70/90	3"	125	176	200

## HIGH LEVEL ROOM SEALED BALANCED FLUE DIMENSIONS

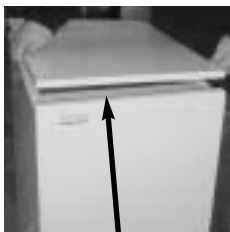

REMOVE CASING LID

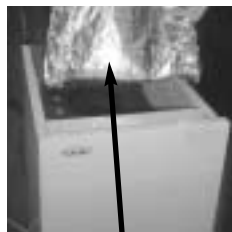

REMOVE FOIL



REMOVE FLUE RING

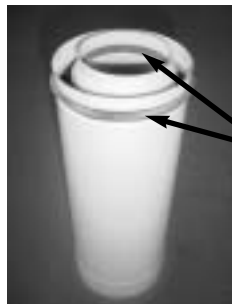

FIT SEALS AND LUBRICATE

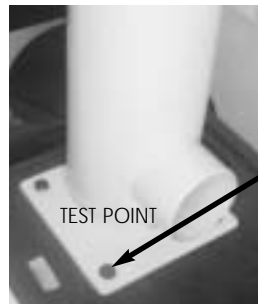

BOLT BOTTOM SECTION TO BOILER

TEST POINT

## INSTALLATION OF HIGH LEVEL BALANCED FLUE

1. Position boiler and Cut Hole in wall. Remember measure, mark, CHECK then cut.
2. Remove Conventional flue ring from top of boiler.

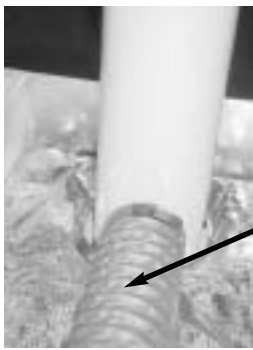

FIT SNORKEL TUBE

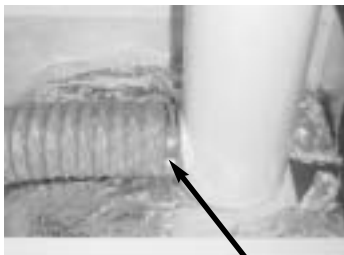

FIT CLIP



FIT LID

3. Fit Red inner seal and Black outer seal to flue connectors and extensions if required.
4. Apply lubricant to the inner and outer seals. Taken care to only lubricant the lip of the seals.
5. Bolt bottom section of the flue to the boiler insuring the square gasket is fitted in between the boiler and the flue.
6. Attached snorkel to the flue with the clip.
7. Refit boiler top panel insure the knock out in the panel has been removed.
8. Assemble second vertical flue section and any vertical extension.
9. Assemble horizontal section and pass through the wall. Making sure that the terminal protrudes through the wall a minimum of 176mm.
10. Connect vertical and horizontal section together.
11. Secure vertical section with the screws provided.
12. Seal around the flue terminal in wall using mastic.
13. Remove CF adaptor from burner and discard.
14. Fit BF adaptor connect snorkeltube with clip.

NOTE: Expanding foam can be used to fill/insulate the gap between flue parts and wall.



INTERNAL VIEW

## FLUE EXTENSIONS

**Please note** a maximum of one kit 6 950mm or 3 x kit 3 300mm extension can be used on the high level.

Kit 8 45 degree bends must not be used on low level balanced flue kits.



FIT HORIZONTAL SECTION

## VERTICAL BALANCED FLUE

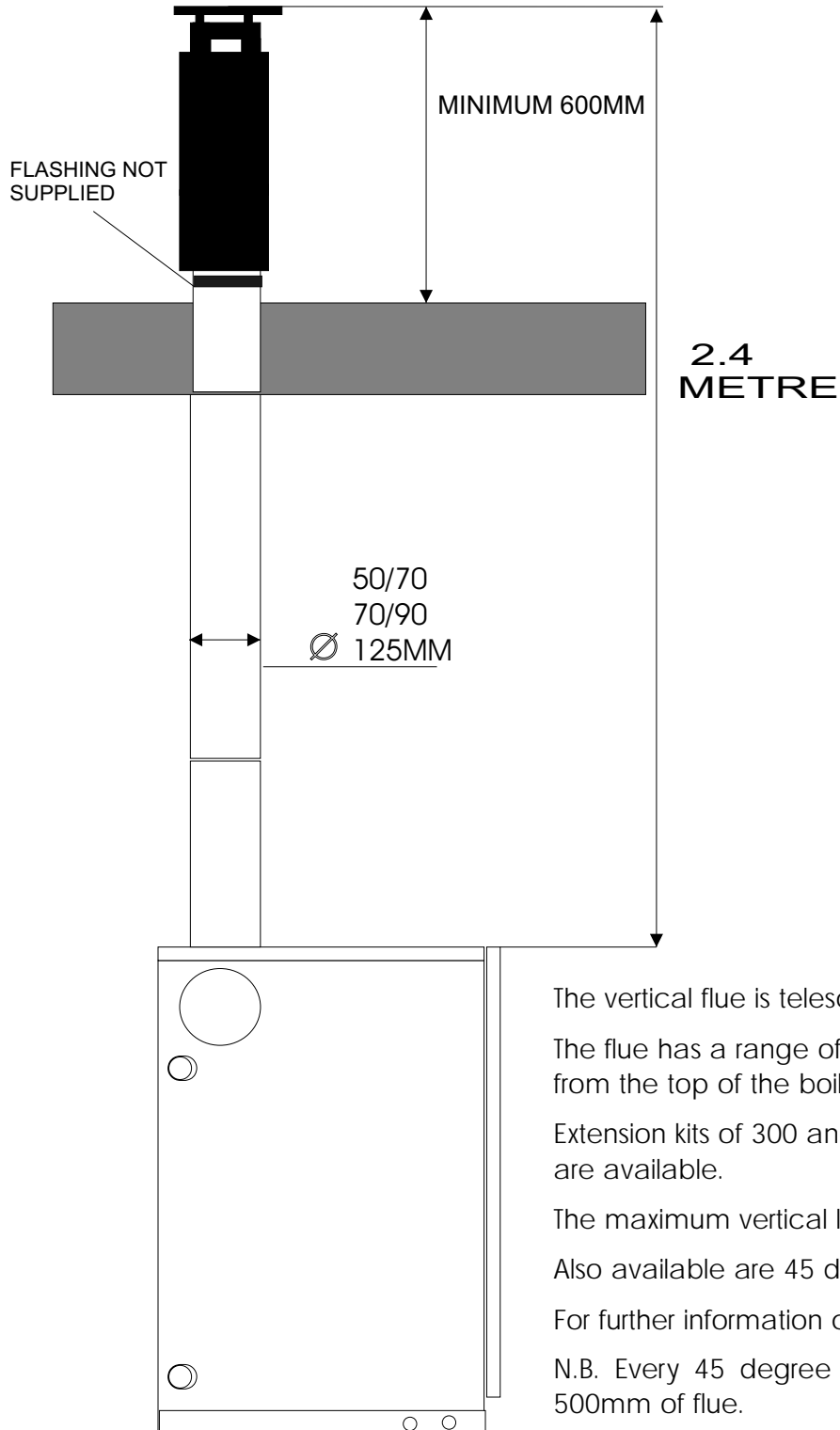

The vertical flue is telescopic as supplied.

The flue has a range of 1020-2400mm from the top of the boiler to the flashing.

Extension kits of 300 and 950mm are available.

The maximum vertical length is 4800mm.

Also available are 45 degree bends.

For further information contact our sales office.

N.B. Every 45 degree elbow is equivalent to 500mm of flue.

## VERTICAL BALANCED FLUE DIMENSIONS

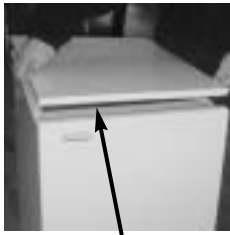

Remove lid

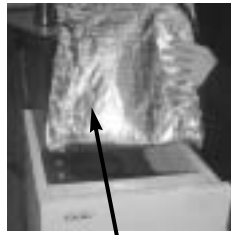

Remove lid



Remove flue ring

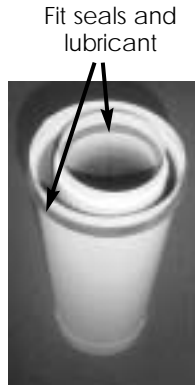

Fit seals and lubricant

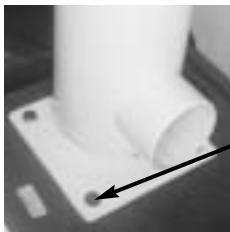

Bolt bottom section



Fit Snorkel Tube

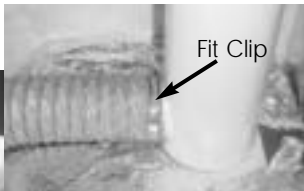

Fit Clip



Vertical Terminal



Internal View

## INSTALLATION OF VERTICAL FLUE

1. Position boiler and cut hole/s in ceiling and roof. Remember measure mark ,CHECK then cut.
2. Remove conventional flue ring from top of boiler.
3. Fit Red inner seal and Black outer seal to flue connectors and extensions if required.
4. Apply lubricant to the inner and the outer seals. Taking care to only lubricant the lip of the seals.
5. Bolt bottom section of the flue to the boiler insuring the square gasket is fitted in between the boiler and the flue.
6. Attached snorkel to the flue with the clip.
7. Refit boiler top panel insure the knock out in the panel has been removed.
8. Assemble second vertical flue section and any vertical extension.
9. Fit the roof flashing and flue terminal.
10. Secure the terminal to a roof joist with clamps provided.
11. Fit flue elbows if required and secure vertical section with the screws provided
12. Seal around the flue terminal in wall using mastic
13. Remove CF adaptor from burner and discard
14. Fit BF adaptor connect snorkel tube with clip.

**NOTE:** Expanding foam can be used to fill/insulate the gap between flue parts and wall.

# FITTING OF BF ADAPTOR



Disconnect Burner Plug



Loosen Bolt



Remove Burner



Remove C F Adaptor

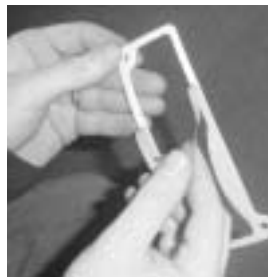

Peel backing sticky from B F adaptor Gasket



Fit B F Adaptor Gasket



Fit B F Adaptor



Tighten bolt on burner



Fit snorkel tube



Internal view

## FLUE KIT DESCRIPTION AND PART NUMBERS

DESCRIPTION	PART NUMBER
	50-90,000BTU
1. LOW LEVEL BALANCED FLUE STANDARD WALL THICKNESS FROM 150-450mm	KIT1-80mm
2. LOW LEVEL BALANCED FLUE EXTENDED WALL THICKNESS FROM 260-600mm	KIT2-80mm
3. 300mm FLUE EXTENSION	KIT3-80mm
4. HIGH LEVEL HORIZONTAL FLUE	KIT4-80mm
5. VERTICAL FLUE	KIT5-80mm
6. 950 MM FLUE EXTENSION	KIT6-80mm
7. 45 DEGREE BENDS	KIT8-80mm

N.B. Kit 8 (45 degree bends) must only be used on kit 5 vertical flue kits.

## OIL SUPPLY

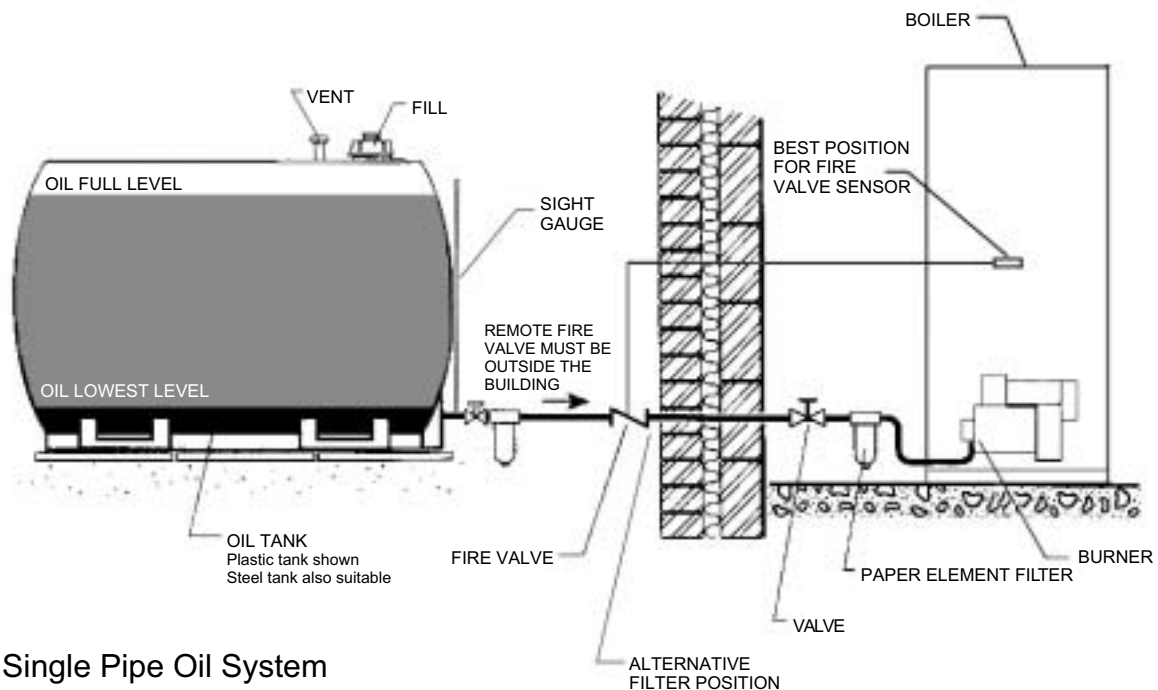

Single Pipe Oil System

TYPICAL SYSTEM SHOWN

## OIL SUPPLY

### Diagrams of twin pipe oil supply systems

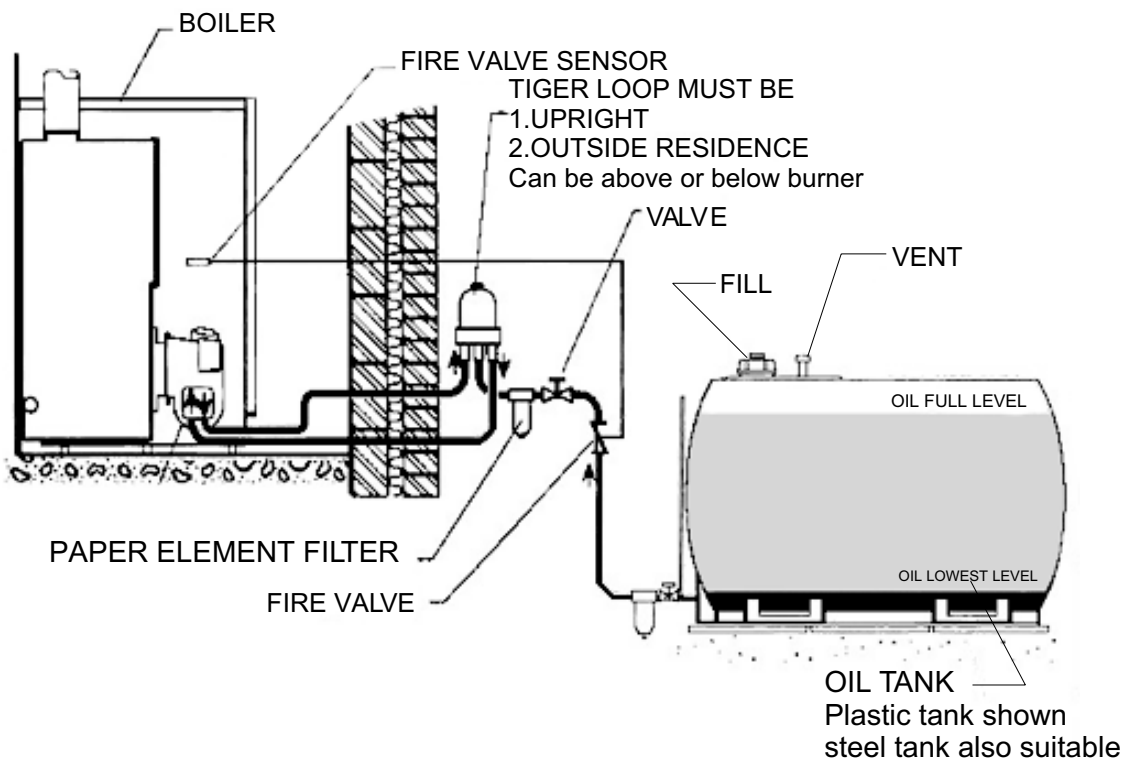
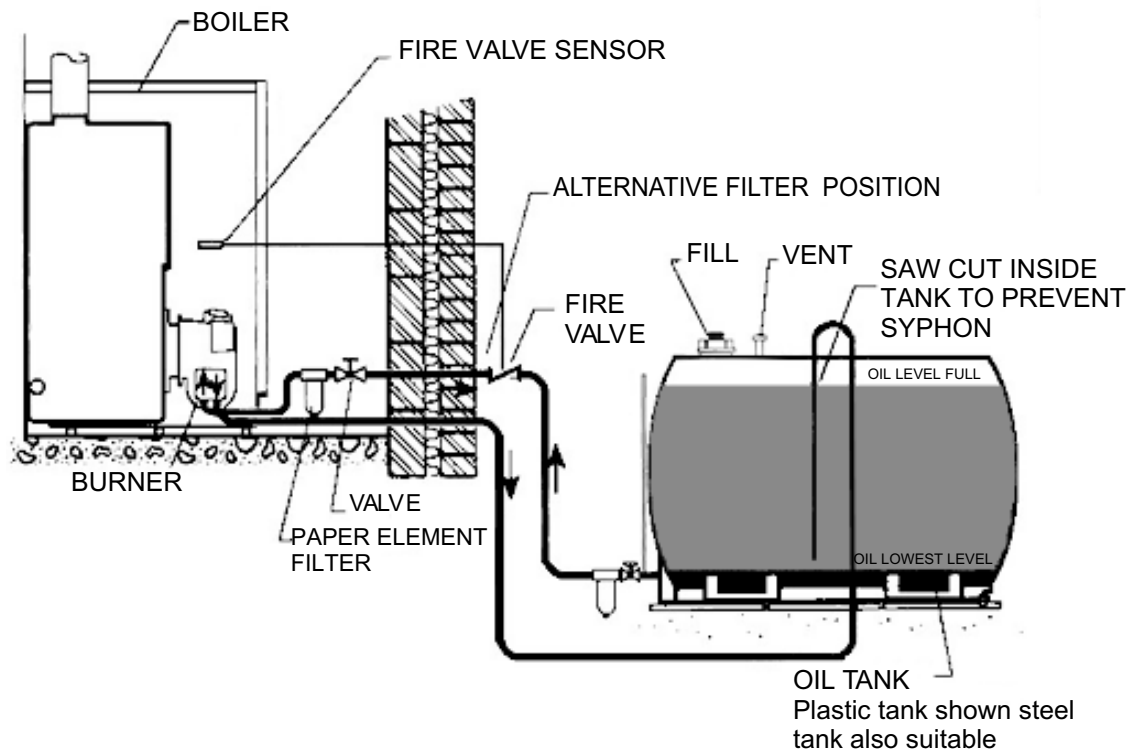

A flexible oil pipe is supplied to connect the burner to the incoming oil supply pipe.

#### IMPORTANT NOTES

- If siting oil tank above burner height, use single supply pipe only.
- If siting oil tank below burner height, use twin pipe supply or Tiger loop.
- Please refer to Burner Manual for conversion to oil pump for two pipe system.

### ELECTRICAL CONNECTION (INTERNAL & EXTERNAL SYSTEM)

The electrical supply to the boiler must be wired using a double pole - isolating switch 240v/50hz fused at 5 amps. A multi 3 pin plug is included with the boiler, which connects with the boiler control panel.

The burner is supplied with 3 wire cable plug, which allows disconnection for maintenance.

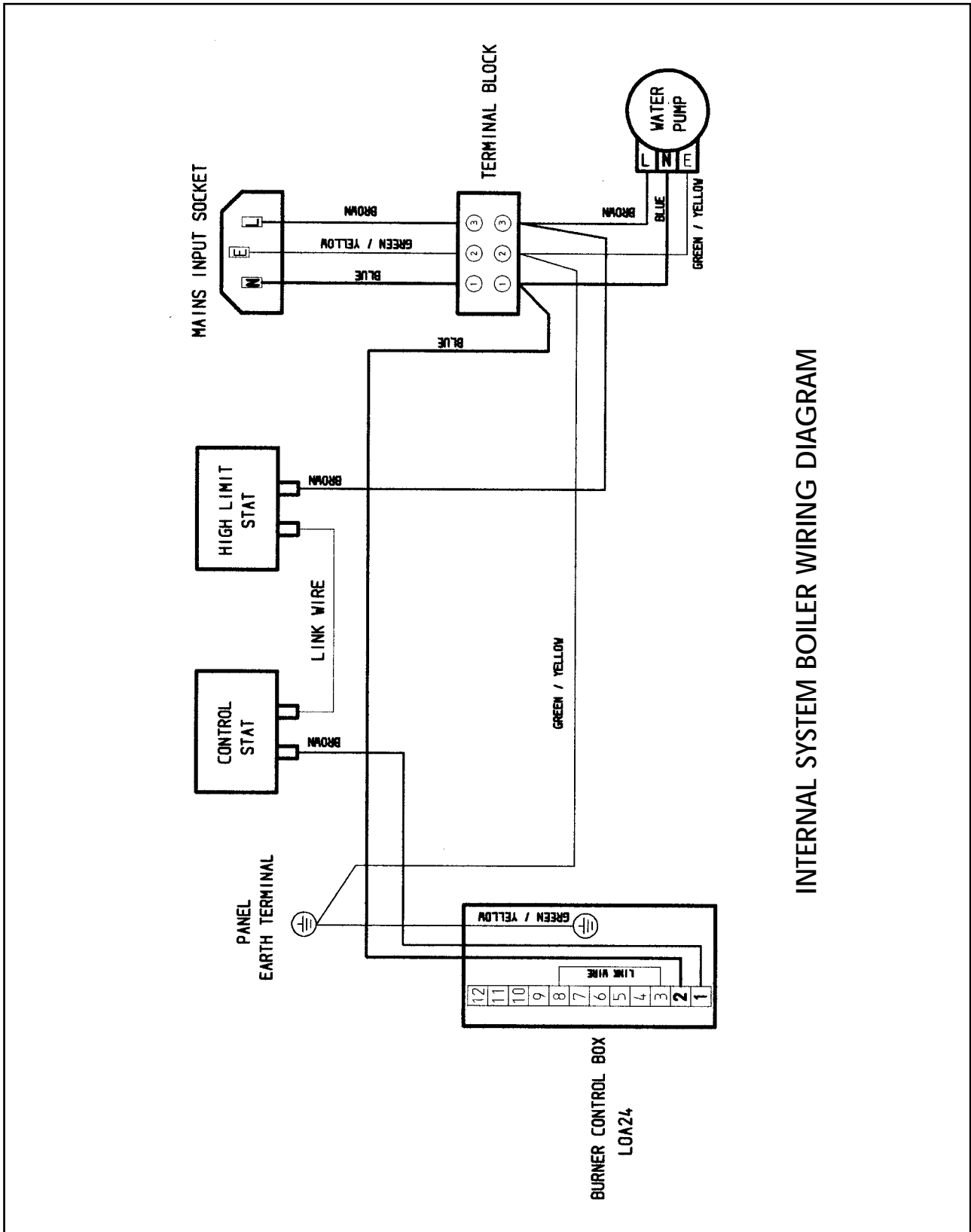

INTERNAL SYSTEM BOILER WIRING DIAGRAM

## Internal System Models Technical Specification

	50/70 SYSTEM	70/90 SYSTEM
	BTU	BTU
A	857	857
B	590	590
C	506	506
D	140	140
E	93	93
F	22	22
G	22	22
H	15	15
I	15	15
J	1" BSP	1" BSP
Water Content	20.5Ltr	20.5Ltr

### General Data

Electrical Supply: 240v ~50Hz

Fuel: 28 second or 35 second

Maximum Control Thermostat Setting 85 °C

Expansion Vessel Capacity 12 Litres

Conventional Size 100-125 mm

Oil Supply Connection ¼" BSP

High Limit Stat: Manual Reset

Maximum Operating Pressure

Spring Safety Valve @ 3Bar

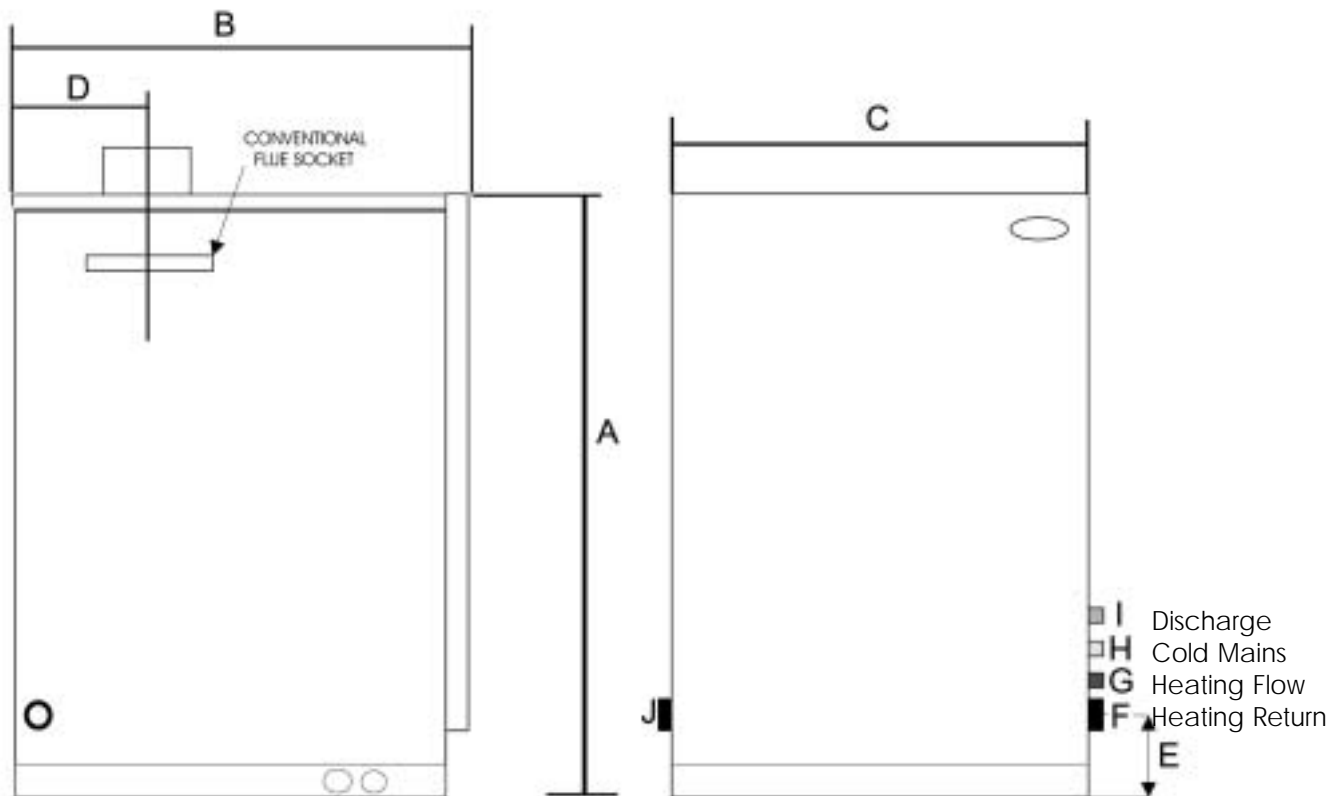

DIMENSIONS IN (MM)

N.B. Heating Return (option) left or right.

## System External Models Technical Specification

	50/70 SYSTEM	70/90 SYSTEM
	BTU	BTU
A	878	878
B	630	630
C	765	765
D	160	160
E	93	93
F	22	22
G	22	22
H	15	15
I	15	15
J	1" BSP	1" BSP
Water Content	20.5Ltr	20.5Ltr

### General Data

Electrical Supply: 240v ~50Hz

Fuel: 28 second

Maximum Control Thermostat Setting 85°C

Expansion Vessel Capacity 12 Litres

Oil Supply Connection ¼" BSP

High Limit Stat: Manual Reset

Maximum Operating Pressure

Spring Safety Valve @ 3Bar

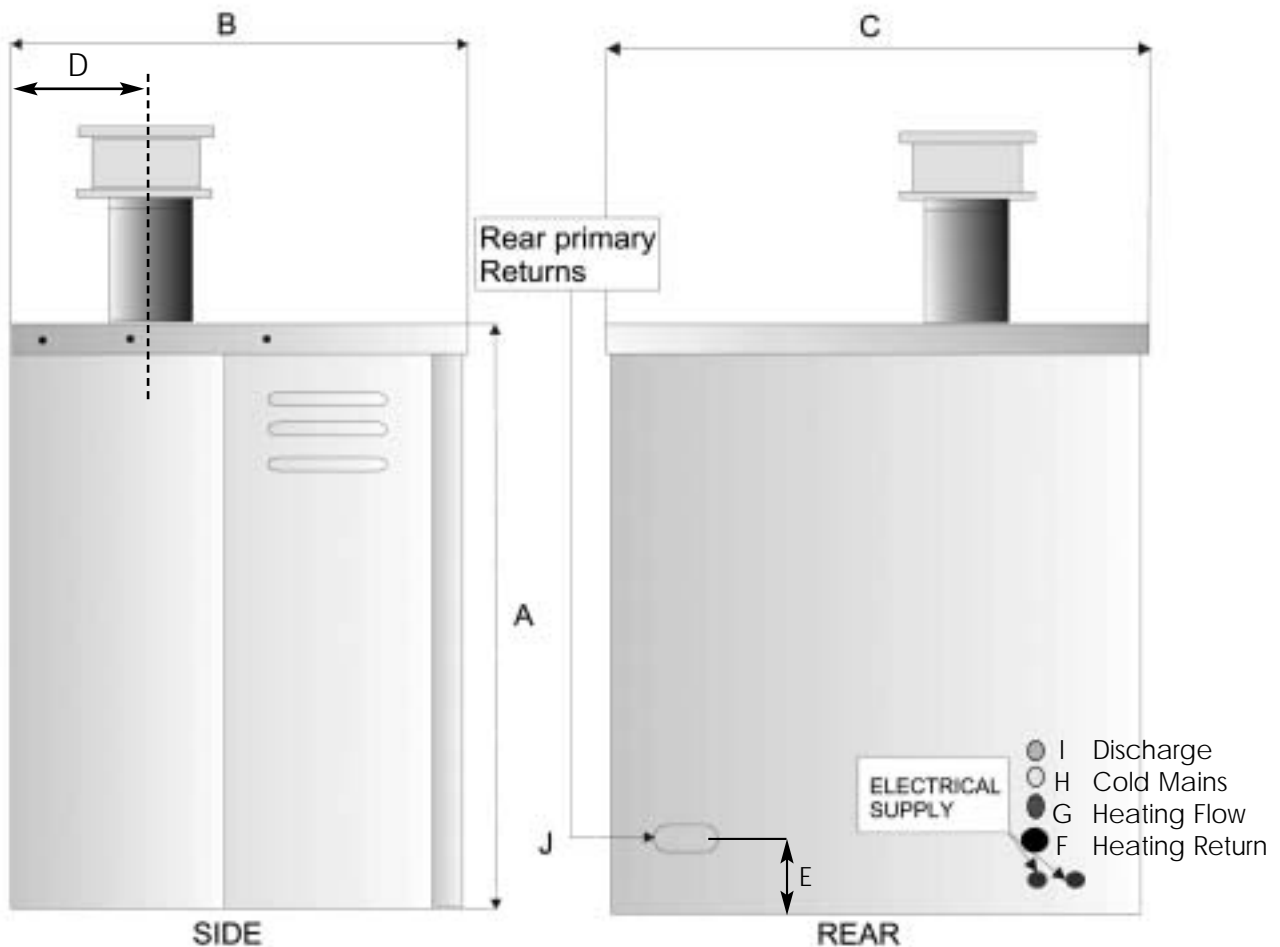

DIMENSIONS IN (MM)

N.B. Heating Return (option) left or right.

## COMMISSIONING INSTRUCTIONS

A competent service engineer OFTEC registered should be appointed on an annual basis.

- Insure heating system has been flushed and treated with inhibitor.
- De-pressurise heating system and check expansion vessel pre-charge is the same as the cold fill pressure of the heating system. Expansion vessel pre-charge must not exceed 1.5 bar.
- Remove inspection door and check baffle arrangement.
- Remove Burner and check electrode settings and also check settings between face of nozzle to diffuser plate.  
Please refer to Burner technical manual for correct settings.
- Fit manifold pressure gauge to the gauge port of the burner.
- Turn electrical supply, to the boiler, to ON.
- Set the central heating controls so they are calling for heat. .
- Set the boiler control thermostat to 80°C.
- Purge air from the oil supply system .
- Set burner pump pressure.
- Allow time for the boiler to reach normal operating temperature.
- Check the smoke reading.
- Measure the Co<sup>2</sup>.
- Measure net flue gas temperature.

### **Please Note:**

Reducing the air supply into the burner air inlet shutter, decreases the flue gas temperature and increases the Co<sup>2</sup>.

## SERVICING INSTRUCTIONS

A competent service engineer OFTEC registered should be appointed on an annual basis.

- Isolate Power to the boiler.
- De-pressurise heating system and check expansion vessel pre-charge is the same as the cold fill pressure, of the heating system. Expansion vessel pre-charge must not exceed 1.5 bar.
- Remove inspection door, Burner and baffle assembly.
- Brush down the inside of the heat exchanger and vacuum out debris .
- Clean Baffle Assembly.
- Inspect and clean burner assembly, and replace nozzle and change flexi oil line if required.
- Renew insulation e.g. inspection door or inside base of heat exchanger, if required.
- Reassemble baffle assembly and replace inspection door.
- Fit manifold pressure gauge, to the gauge port of the burner
- Turn electrical supply, to the boiler, to ON.
- Set central heating controls so they are calling for heat. .
- Set burner pump pressure.
- Allow time for the boiler to reach normal operating temperature.
- Check the smoke reading
- Measure the  $\text{Co}^2$ .
- Measure net flue gas temperature.

### **Please Note:**

Reducing the air supply into the burner air inlet shutter, decreases the flue gas temperature and increases the  $\text{Co}^2$ .

## BOILER WILL NOT START

Check if mains electricity supply is reaching boiler control panel, making sure control thermostat is turned on and time clock is calling for heat. Mains indicator green should be illuminated. If green light is not illuminated and fuse has been checked, then heating system charge may be low, check black needle on pressure, located inside boiler cabinet (top right hand side) is reading 1 bar or more. If not repressurize, refer to fault diagnosis on page 32

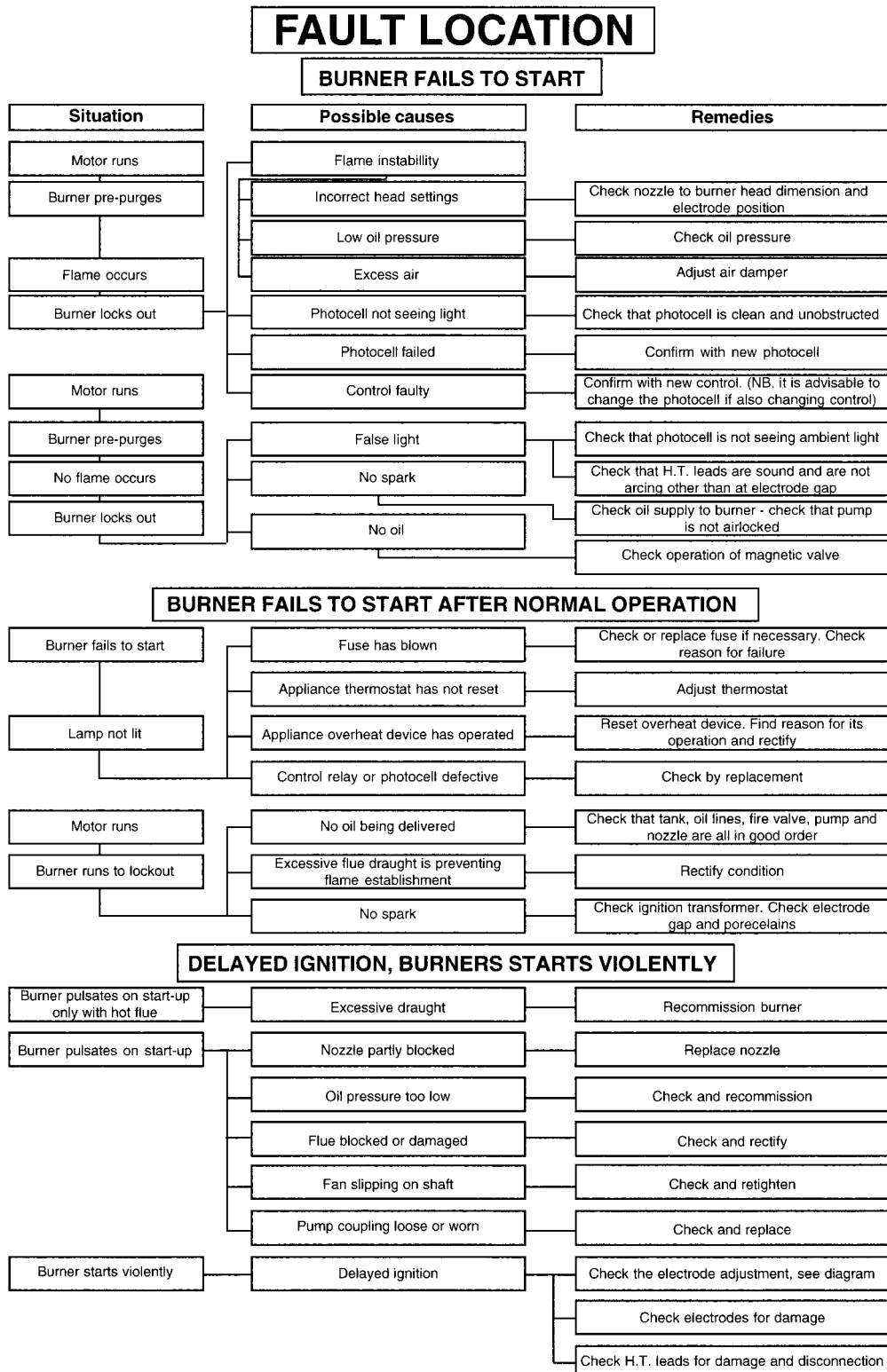

# PARTS LIST



ITEM	DESCRIPTION	PART No.
1	Control Thermostat	COTHCS
2	High Limit Thermostat	COTHHL
3	Safety Relief Valve	COMPRES
4	Gate Valves	COMGATE
5	Grunfoss 25-50	GRUN50
6	Filling Loop	COMLOOP
7	Expansion Vessel Hose	COMHOS
8	12 Litre Expansion Vessel	COM12L
9	Door Insulation Kit	INSKIT
10	50/70 Baffle 70/90 Baffle Burner See Burner Parts List	

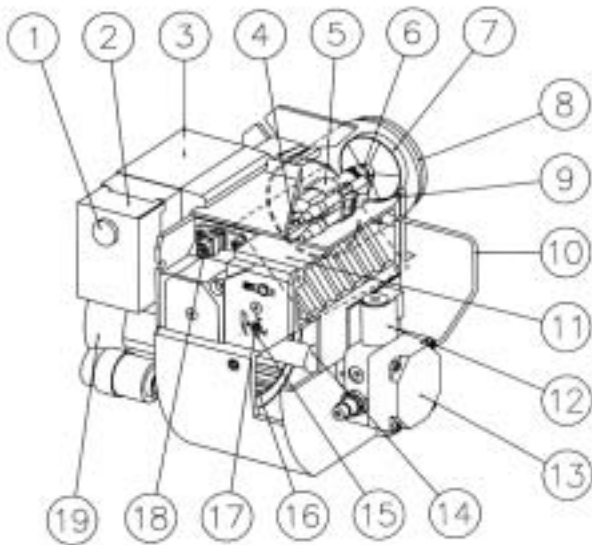

ITEM	DESCRIPTION	PART No.
1	Reset Button	N/A
2	Control Box	LOA24CBOX
3	Ignition Transformer	STREBI
4	Ignition Cables	STRHT
5	Nozzle Assembly	N/A
6	Nozzle	NOZZ011
7	Brake Plate	N/A
8	Blast Tube	ST40STR40BLAST
8	Blast Tube	ST 50STR50BLAST
9	Ignition Electrodes	STRMONO
10	Connecting Pipe	N/A
11	Air Damper	N/A
12	Solenoid Valve	DANCOIL
13	Pump	DANBFP11L
14	Drive Coupling	STRCOUP
15	Indication Air Damper	N/A
16	Fan Wheel ST40	STR40FAN
16	Fan Wheel ST50	STR50FAN
17	Adjustment, Air Damper	N/A
18	Photo Resistor	STRPHOTO
19	Motor	STR90WATT

## BURNER SETTINGS

BOILER MODEL		50/70	70/90
OUTPUT	Btu/h x 100	70	90
OUTPUT	kw	20.5	26.4
NOZZLE SIZE AND TYPE	US/GPH	0.60	0.65
		80 S	80 S
OIL PRESSURE	BAR	9.5	10
FIRING RATE	Kg/hr	1.95	2.44
AIR SETTING APPROX.	SCALE No.	12	14
SMOKE	Bacharach Scale	0	0
Co <sup>2</sup>	%	12	12.5
FLUE GAS TEMP.	Less Ambient C	Minimum Temp. 160° C	Maximum Temp. 260° C

These figures are to be used as a guide.

Site conditions may require adjustment to achieve most efficient combustion.





## **TURKINGTON ENGINEERING LIMITED**

Unit 12, Whitegate Industrial Estate, Wrexham LL13 8UG

Telephone: 01978 363048 or 01978 363049

Fax: 01978 363046



Copyright of the contents of this manual is secured by Turkington Engineering Limited and neither the manual nor any part may be reproduced without permission.

Turkington Engineering Limited have a continuing research and development programme which occasionally necessitates changes to specifications herein. It is, therefore essential that instructions issued with each individual appliance are carefully read prior to installation and strictly adhered to during installation.

The statutory rights of the customer are not affected.